

3" TO 75 mm REDUCER

TO CONVERT 3" HUB TO METRIC 75 mm PIPE

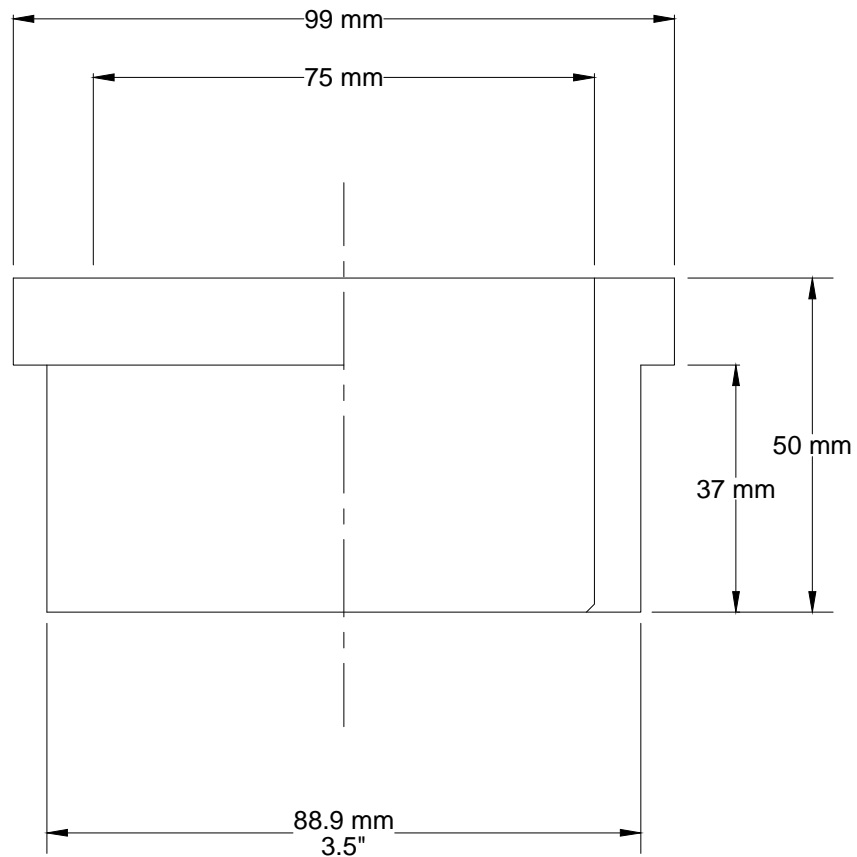

FUNCTION OF COMPONENT

* Convert 3" hub to metric 75 mm pipe.



PROSET[®]
SYSTEMS
FIRESTOP PENETRATOR[™]

DATE :

7-10-11

DRG . NO .

MP3