

WATERPROOF RISER CLAMP DEVICE

PRECAST CONCRETE OR EXISTING CONCRETE
FOR FLOORS

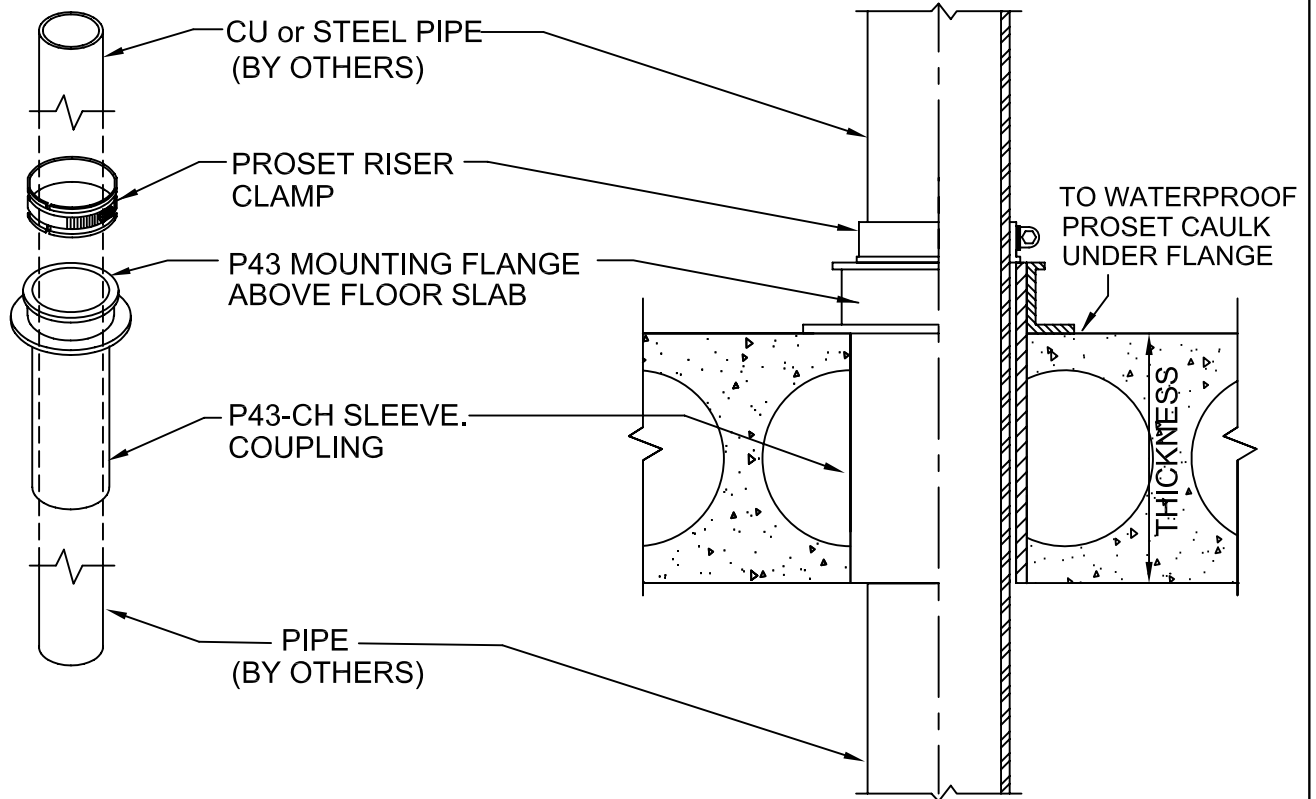

Size	Part No.	Description	Price	Unit Total	Core Size
2"	P2543H-B or G-CHE A02214	2" Sleeve Coupling	6.30	9.00	2 3/4"
		2" Riser Clamp	2.70		
2½"	P3843H-CHE A03212	2½" Sleeve Coupling	10.00	13.50	4"
		2½" Riser Clamp	3.50		
3"	P3543H-B or G-CHE A03214	3" Sleeve Coupling	8.70	11.70	4"
		3" Riser Clamp	3.00		
4"	P4543H-B or G-CHE A04214	4" Sleeve Coupling	10.80	14.55	5"
		4" Riser Clamp	3.75		
5"	P6843H-CHE A05214	5" Sleeve Coupling	19.10	25.10	7-1/2"
		5" Riser Clamp	6.00		
6"	P6543H-B-CHE A06214	6" Sleeve Coupling	16.20	22.35	7-1/2"
		6" Riser Clamp	6.15		

Use "B" Black letter sleeve pipe for cast iron, glass or steel or "G" Green for copper or plastic
Use suffix CU for copper -CI for cast iron -S for steel pipe when ordering Riser Clamps.



W.H. Directory Reference 97 Edition
Firestop Device
W.H. Design No. PS/PHV 180-01
F Rating 3 Hrs.



PROSET[®]
SYSTEMS
FIRESTOP PENETRATOR™

DATE :
8-10-11
DRG. NO.
A-1014-DWP