

PART NO.	TRAP GUARD DESCRIPTION	PRICE
TG15PT	1-1/2" TG Fits inside 1-1/2" PVC Pipe	\$ 30.00
SG22P	2" Suds Guard Fits inside 2" PVC	\$ 30.00
SG22IP	2" Suds Guard Fits inside 2" C.I. Pipe	\$ 30.00
TG22P	2" TG Fits inside 2" PVC Pipe	\$ 30.00
TG22IP	2" TG Fits inside 2" C.I. Pipe	\$ 30.00
TG22G	2" TG Fits through a 2" gasket to inside pipe	\$ 30.00
TG22SC	2" TG Fits into 842-2 Sioux Chief tailpiece	\$ 30.00
TG33IP	3" TG Fits inside 3" C.I. Pipe	\$ 34.00
TG33G	3" TG Fits through a 3" gasket to inside pipe	\$ 34.00
TG33P	3" TG Fits inside PVC Pipe	\$ 34.00
TG33SC	3" TG Fits into 842-3 Sioux Chief tailpiece	\$34.00
TG34G	3" TG Fits through a 4" gasket to inside pipe	\$ 38.00

- To make a watertight seal, use an adhesive type caulk around the bottom of the top flange and then insert Retrofit Trap Guard into the 2" or 3" pipe or tailpiece.

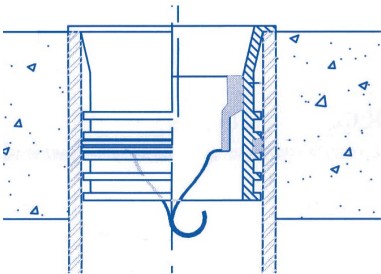

PART NO.	TRAP GUARD DESCRIPTION	PRICE
TG34IP	3" TG Fits inside 4" PVC or C.I. Pipe	\$ 44.00
TG36IP	6" TG Fits inside 6" PVC or C.I.	\$ 50.00

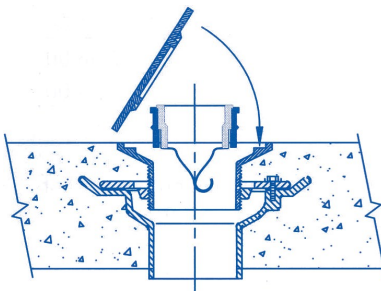

PART NO.	TRAP GUARD DESCRIPTION	PRICE
TG3H	3" TG Fits inside Smith 2000 and Josam 3000	\$ 40.00
TG34HM	3" TG Fits inside Mifab Tailpiece	\$ 42.00
TG34HW	3" TG Fits inside Watts Tailpiece	\$ 42.00
TG34SC	3" TG Fits into 842-4 Sioux Chief tailpiece	\$ 42.00

- All of the above are pressed to fit into the tailpiece of the drain.

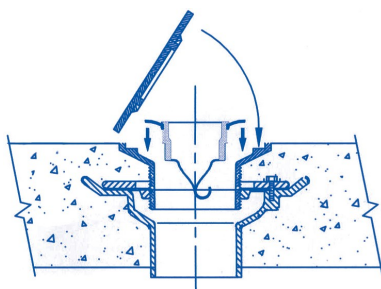

PART NO.	TRAP GUARD DESCRIPTION	PRICE
TG33Zurn	3" TG Fits inside Z415 Tailpiece	\$ 38.00
TG33Wade	3" TG Fits inside Wade Tailpiece	\$ 35.00
TG34TP	3" TG Fits inside 4" strainer tailpiece	\$ 38.00

- Use an adhesive type caulk around the bottom of the flange to seal

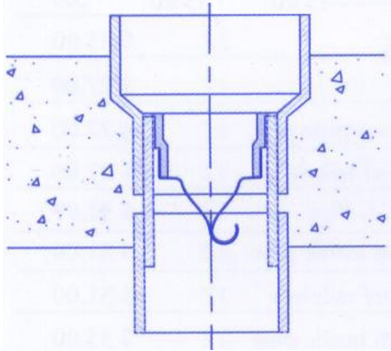

PART NO.	TRAP GUARD DESCRIPTION	PRICE
TG23HD	2" X 3" TG Underground Hub Drain	\$ 37.95
TG24HD	2" X 4" TG Underground Hub Drain	\$ 42.90
TG34HD	3" X 4" TG Underground Hub Drain	\$ 46.20
TG23HD-CI	For Cast Iron connections, add CI to part no.	Add \$ 3.75
TG23HD-RS	For recessed strainer 1-1/4", add RS to part no.	Add \$ 3.50

- The underground Hub Drains, above, are usually used for AC condensate drains and water heater relief valve drains. They come with a concrete protective cap.

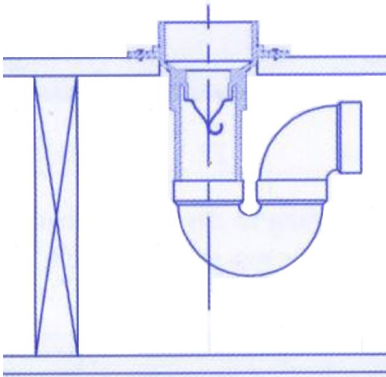

PART NO.	TRAP GUARD DESCRIPTION	PRICE
TG23FHD	2" X 3" TG Above Ground Hub Drain	\$ 42.90
TG23FHDS	Same as above with strainer	\$ 46.20
TG24FHD	2" X 4" TG Above Ground Hub Drain	\$ 48.95
TG24FHDS	Same as above with strainer	\$ 52.80
TG34FHDS	3" X 4" TG Above Ground Hub Drain With Strainer	\$ 53.35
TG23FBHD	2" X 3" TG Above Ground Bottom Mount Hub Drain	\$ 42.90
TG23FBHDS	Same as above with flush strainer	\$ 46.75

- For recessed strainer add RS instead of S. e.g. TG23FHDRS
- The above Ground Hub Drains have a flange with holes for securing and waterproofing the drain through a wood floor. Use an adhesive caulk under the flange to waterproof.
- Both of the above drains have a built-in Trap Guard and come with a 10-year limited warranty. Other Drains are available for above ground concrete floors.

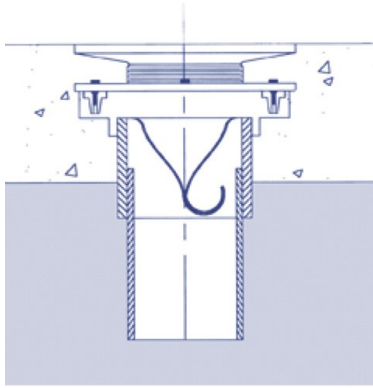

Connect to plastic pipe in ground floor slab

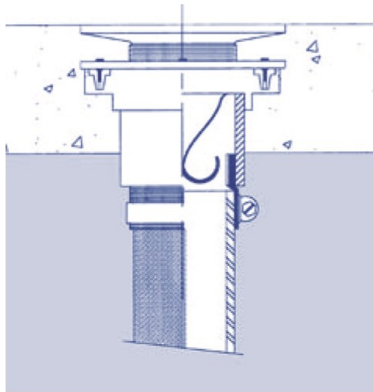

Connect to cast iron pipe in ground floor

PART NO.	TRAP GUARD DESCRIPTION	PRICE
T25630-F-P	2" Adj. NB ED w/ PVC plastic hub joint	\$ 100.65
T35630-F-P	3" Adj. NB ED w/ PVC plastic hub joint	\$ 103.95
T45630-F-P	4" Adj. NB ED w/ PVC plastic hub joint	\$ 106.15

- All above Trap Guard drains have 5" Nickel Bronze round tops

T35630-F-P-CP	Add CP to part no. for 5" chrome strainer and tailpiece	N.C.
T35630-F-P-PB	Add PB to part no. for 5" brass strainer and tailpiece	N.C.
T35630-F-P-SQ	Add SQ to part no. for 5" square strainer	Add \$ 5.00
T35630-F-P-FU	Add FU for 2-3/8"X3-1/2" funnel top drain	Add \$ 25.00

- Above square drain is Nickel Bronze—For Chrome or Brass add CP or PB
- All above drain numbers are for 3". For 2" or 4", change the first number to 2 or 4

PART NO.	TRAP GUARD DESCRIPTION	PRICE
T25630-F-CI	2" Adj. NB ED w/ mechanical hub joint for C.I.	\$ 104.10
T35630-F-CI	3" Adj. NB ED w/ mechanical hub joint for C.I.	\$ 107.75
T45630-F-CI	4" Adj. NB ED w/ mechanical hub joint for C.I.	\$110.95

- All above Trap Guard drains have 5" Nickel Bronze round tops

T35630-F-CI-CP	Add CP to part no. for 5" chrome strainer and tailpiece	N.C.
T35630-F-CI-PB	Add PB to part no. for 5" brass strainer and tailpiece	N.C.
T35630-F-CI-SQ	Add SQ to part no. for 5" square strainer	Add \$ 5.00
T35630-F-CI-FU	Add FU for 2-3/8"X3-1/2" funnel top drain	Add \$ 25.00

- Above square drain is Nickel Bronze—For Chrome or Brass add CP or PB
- All above drain numbers are for 3". For 2" or 4", change the first number to 2 or 4

Above Ground Floor Drains

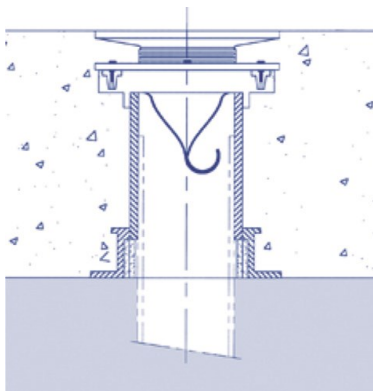

Connect to plastic pipe above ground floor slab

PART NO.	TRAP GUARD DESCRIPTION	PRICE
T2563H-F-SSW	2" Adj. NB ED for plastic pipe above ground floor	\$112.75
T3563H-F-SSW	3" Adj. NB ED for plastic pipe above ground floor	\$130.35
T4563H-F-SSW	4" Adj. NB ED for plastic pipe above ground floor	\$144.65

- H = pour depth of floor—Change the H in the part number to the pour height. e.g. H = 6"
- All above Trap Guard drains have 5" Nickel Bronze round tops

T3563H-F-SSW-CP	Add CP to part no. for 5" chrome strainer and tailpiece	N.C.
T3563H-F-SSW-PB	Add PB to part no. for 5" brass strainer and tailpiece	N.C.
T3563H-F-SSW-SQ	Add SQ to part no. for 5" square strainer	Add \$ 5.00
T3563H-F-SSW-FU	Add FU for 2-3/8"X3-1/2" funnel top drain	Add \$25.00

- Above square drain is Nickel Bronze—For Chrome or Brass add CP or PB
- All above drain numbers are for 3". For 2" or 4", change the first number to 2 or 4

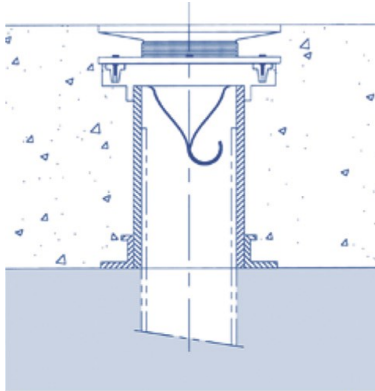

Connect to cast iron pipe above ground floor slab

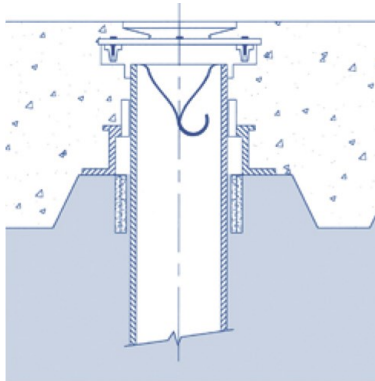

Connect to plastic pipe in metal deck floor slab

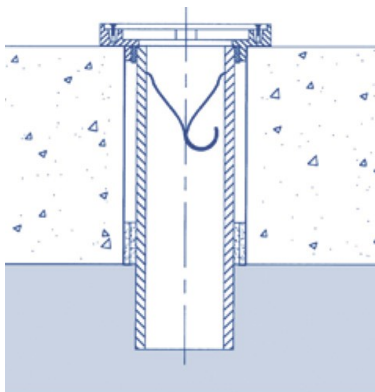

Connect to plastic pipe through cored floor slab

PART NO.	TRAP GUARD DESCRIPTION	PRICE
T2563H-F-CI	2" Adj. NB ED for C.I. pipe above ground floor	\$ 106.30
T3563H-F-CI	3" Adj. NB ED for C.I. pipe above ground floor	\$116.60
T4563H-F-CI	4" Adj. NB ED for C.I. pipe above ground floor	\$121.90

- H = pour depth of floor—Change the H in the part number to the pour height. e.g. H = 6"
- **All above Trap Guard drains have 5" Nickel Bronze round tops**

T3563H-F-CI-CP	Add CP to part no. for 5" chrome strainer and tailpiece	N.C.
T3563H-F-CI-PB	Add PB to part no. for 5" brass strainer and tailpiece	N.C.
T3563H-F-CI-SQ	Add SQ to part no. for 5" square strainer	Add \$ 5.00
T3563H-F-CI-FU	Add FU for 2-3/8"X3-1/2" funnel top drain	Add \$25.00

- Above square drain is Nickel Bronze—For Chrome or Brass add CP or PB
- **All above drain numbers are for 3". For 2" or 4", change the first number to 2 or 4**

PART NO.	TRAP GUARD DESCRIPTION	PRICE
T2563H-F-SSW-CM	2" Adj. NB ED for plastic in corrugated metal floor	\$123.050
T3563H-F-SSW-CM	3" Adj. NB ED for plastic in corrugated metal floor	\$117.60
T4563H-F-SSW-CM	4" Adj. NB ED for plastic in corrugated metal floor	\$147.60

- H = pour depth of floor—Change the H in the part number to the pour height—e.g. H = 6"
- **All above Trap Guard drains have 5" Nickel Bronze round tops**

T3563H-F-SSW-CM-CP	Add CP to part no. for 5" chrome strainer and tailpiece	N.C.
T3563H-F-SSW-CM-PB	Add PB to part no. for 5" brass strainer and tailpiece	N.C.
T3563H-F-SSW-CM-SQ	Add SQ to part no. for 5" square strainer	Add \$ 5.00
T3563H-F-SSW-CM-FU	Add FU for 2-3/8"X3-1/2" funnel top drain	Add \$25.00

- Above square drain is Nickel Bronze—For Chrome or Brass add CP or PB
- **All above drain numbers are for 3". For 2" or 4", change the first number to 2 or 4**

PART NO.	TRAP GUARD DESCRIPTION	PRICE
T2563H-F-SSW-CH	2" Adj. NB ED for plastic pipe through cored hole	\$ 98.25
T3563H-F-SSW-CH	3" Adj. NB ED for plastic pipe through cored hole	\$112.75
T4563H-F-SSW-CH	4" Adj. NB ED for plastic pipe through cored hole	\$125.15

- H = pour depth of floor—Change the H in the part number to the pour height—e.g. H = 6"
- **All above Trap Guard drains have 5" Nickel Bronze round tops**

T3563H-F-SSW-CH-CP	Add CP to part no. for 5" chrome strainer and tailpiece	N.C.
T3563H-F-SSW-CH-PB	Add PB to part no. for 5" brass strainer and tailpiece	N.C.
T3563H-F-SSW-CH-SQ	Add SQ to part no. for 5" square strainer	N.A
T3563H-F-SSW-CH-FU	Add FU for 2-3/8"X3-1/2" funnel top drain	Add \$25.00

- **All above drain numbers are for 3". For 2" or 4", change the first number to 2 or 4**

Limited Parts Warranty

Sellers products are carefully inspected for manufacturing defects; however, it is not always possible to detect hidden defects. Said products are warranted only to the extent that seller will replace without charge, products proved to have manufacturing defects within 6 months of date of delivery thereof and provided seller has been given opportunity to inspect the product alleged to be defective and the installation or use thereof. NO WARRANTY IS INCLUDED AGAINST ANY EXPENSE FOR REMOVAL, REINSTALLATION OR OTHER CONSEQUENTIAL DAMAGES ARISING FROM ANY DEFECT. THE WARRANTIES SET OUT ABOVE ARE THE ONLY WARRANTIES MADE BY SELLER AND ARE EXPRESSLY IN LIEU OF ALL OTHER WARRANTES, EXPRESSED OR IMPLIED, INCLUDING THE WARRANTIES OR MECHANTABILITY AND FITNESS FOR A PARTICULAR PURPOSE .

